

Marcos y respectivos Soportes de Fijación de la Matriz Europea - Dimensiones (mm)

Ref. 42993 - Soporte de Fijación

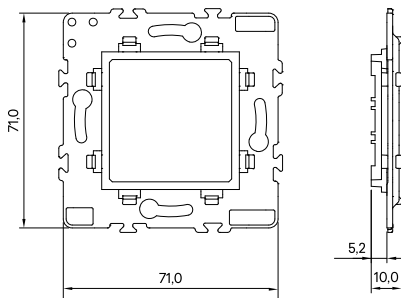

Ref. 42994 - Soporte de Fijación con Garras

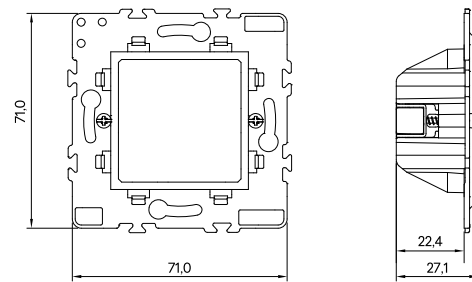

Ref. 42910 T - Simple (Standard, Aquarella, Lyra, Ligna, Metallum)

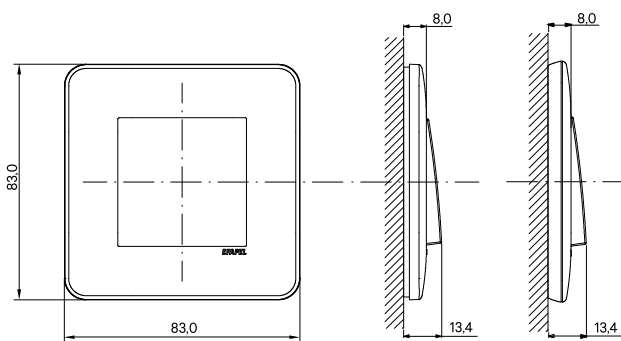

Ref. 42920 T - Doble (Standard, Aquarella, Lyra, Ligna, Metallum)

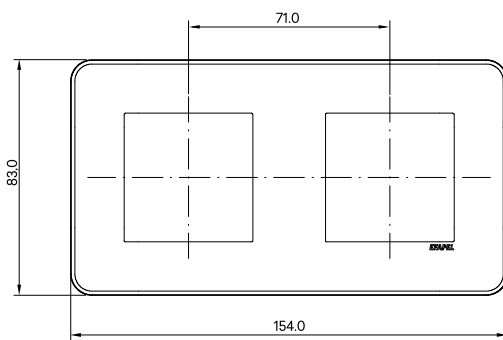

Ref. 42930 T - Triple (Standard, Aquarella, Lyra, Ligna, Metallum)

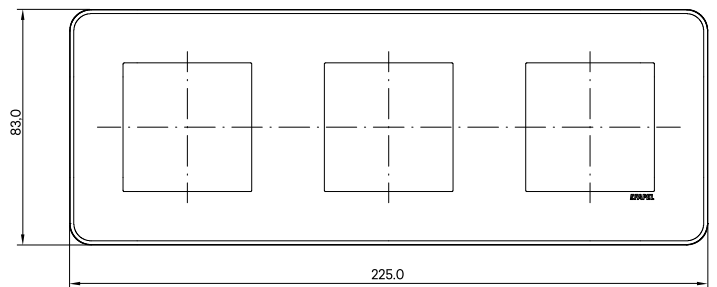

Ref. 42940 T - Cuádruple (Standard, Aquarella, Lyra, Ligna, Metallum)

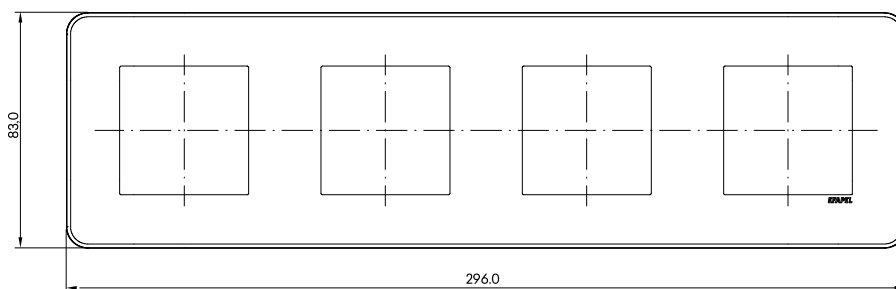

Marcos y respectivos Soportes de Fijación de la Matriz Europea - Dimensiones (mm)

Ref. 42993 - Soporte de Fijación

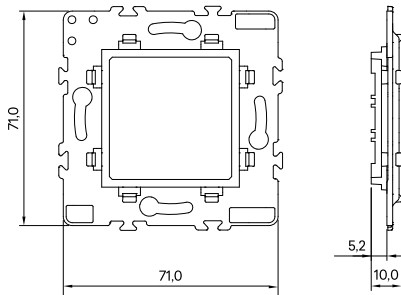

Ref. 42994 - Soporte de Fijación con Garras

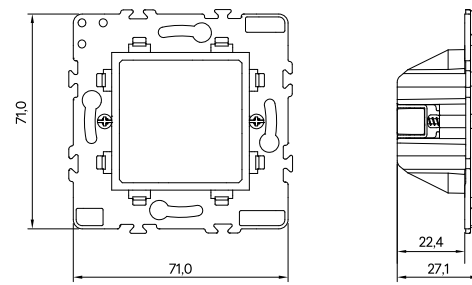

Ref. 42910 T - Simple (Croma)

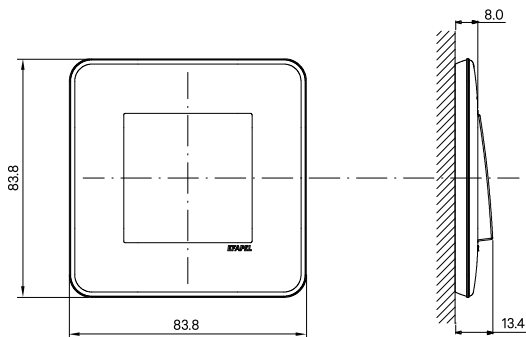

Ref. 42920 T - Doble (Croma)

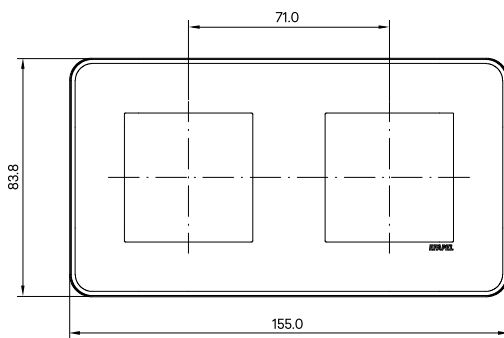

Ref. 42930 T - Triple (Croma)

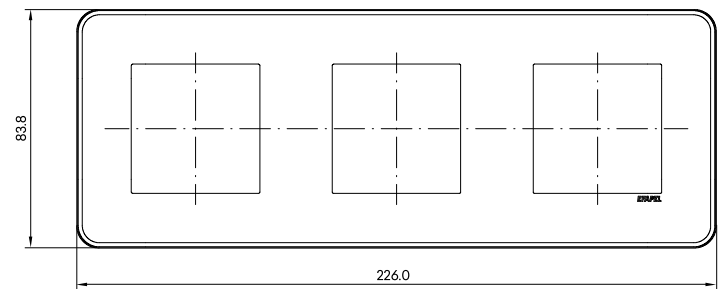

Ref. 42940 T - Cuádruple (Croma)

